

UNIVERSAL SHAFT

GROVE

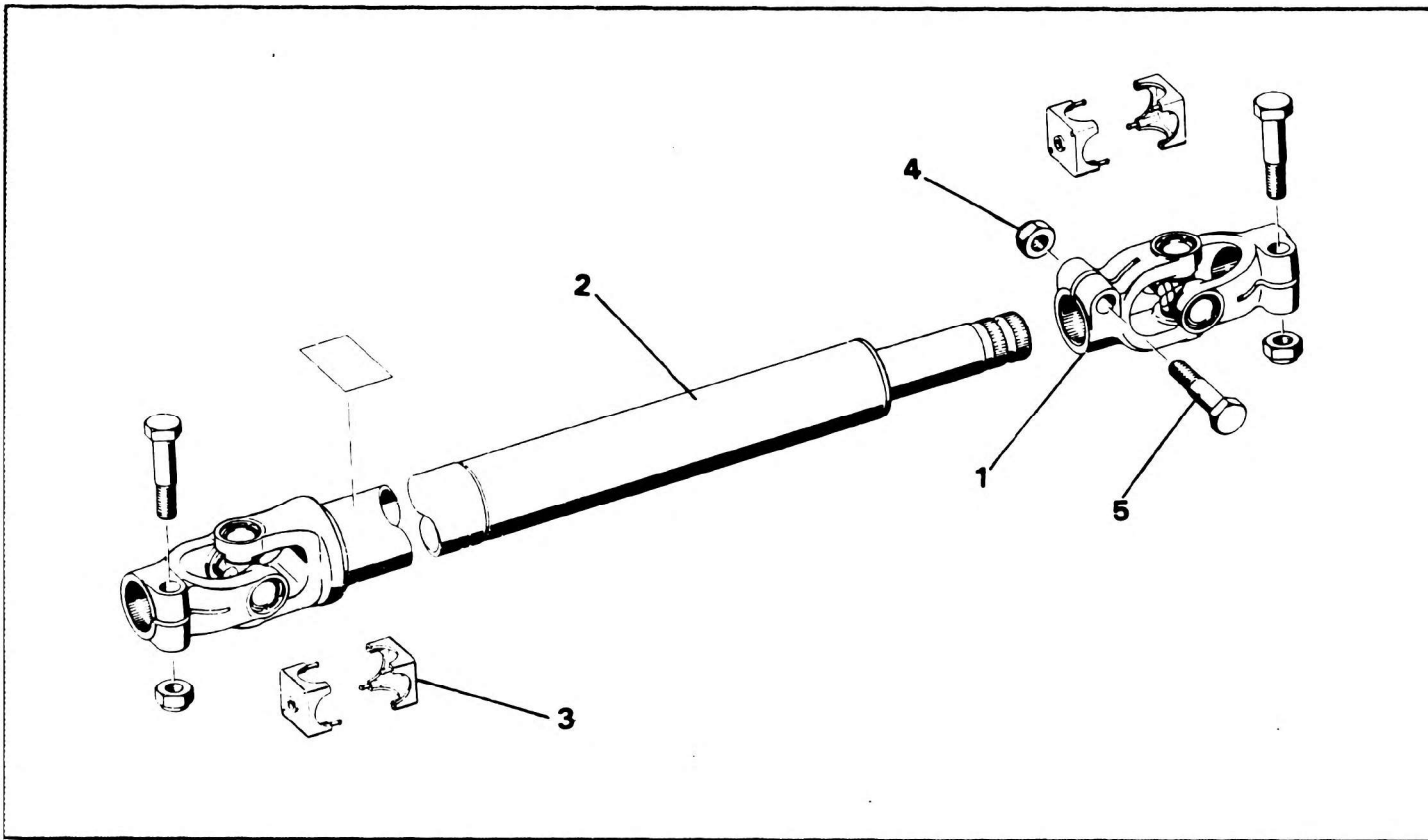

NO.	PART NO.	QTY	DESCRIPTION	NO.	PART NO.	QTY	DESCRIPTION
	7-810-002055		COMPLETE ASSY				
1	NOT SERVICED	1	UNIVERSAL SHAFT				
2	NOT SERVICED	1	SHAFT, SPLINED				
3	NOT SERVICED	2	CAP, PROTECTING				
4	9-810-10092	3	NUT				
5	7-099-000588	3	PLATE				